



DEUTSCH

BRANCHE CONNECTEURS AEROMILITAIRES



## *Single Module EN4165*

*Arinc 809 - BACC65 - EN4165*

The DMC-M is a modular rectangular connector which was designed and developed by Deutsch in the 1980's. It has since set the modular connector standard in the Aerospace & Military industries, and is now standardised by European Specification **EN4165**.

### ■ The modularity

The DMC-M is designed to address a wide range of requirements due to its wide range of contacts arrangements : from contacts size 22 to size 8, but also coaxial, quadrx, **high speed Ethernet or optical contacts**.

Each mated half of the DMC-M connector can contain both male and female configurations which allow you to mix input and output with signal and power supply. You can easily modify your system by simply removing modules from the shells and replace them with a new layout. This makes the DMC-M perfect for both **new designs** and **retrofit applications**.



### ■ The safety

The DMC-M provides a large number of insert layout possibilities. It allows different keying possibilities between plugs and receptacles.

The DMC-M provides a real EMI protection following most stringent Aerospace and Military specifications. In addition of Series II, DMC-M scoop proof Series III inserts and shells are **developped to increase mating security**.



### ■ The reliability

To increase the level of reliability of the cabin interconnections, the Single Module DMC-M is compliant with the most demanding avionic specifications, in terms of **sealing**, vibrations, **smoke and toxicity** or mechanical endurance in accordance with EN4165.



### ■ The weight optimization

Weight saving is commonly a high concern, the Single Module DMC-M has been designed in **composite** with a metallized plating for weight and mass saving.





ARINC809 - BACC65 - EN4165

The New Standard Connector for Aircraft equipment and cabin systems.

### Advantages

Light weight composite, modularity, color and mechanical coded, push pull coupling are the key features of this connector. In addition the EN4165 range is aluminium cable contact compliant.

### Standard

ARINC809, BACC65, EN4165 qualified

### Markets & Application

Cabin and avionic systems  
Military - Railway

### Technical characteristics

Housing : Composite  
 Plating : Nickel  
 Inserts : Thermoplastic and FSR  
 Vibrations : 20 g  
 Durability : 500 mating cycles  
 Salt spray : 500 hours  
 Contacts : Copper alloy with gold on nickel plating  
 Interfacial sealing:  $1,1 \cdot 10^{-2}$  bar

### Electrical characteristics

Temperature range : -55° C to + 175° C  
 Insulation resistance :  $\geq 5000 \text{ M}\Omega$   
 Maximum current : Size 22 : 5 A  
                               Size 20 : 7,5 A  
                               Size 16 : 13 A  
                               Size 12 : 23 A  
                               Size 8 : 46 A

### EMI shielding performance

MHz frequency	100	200	300	400	800	1000
Attenuation (dB)	90	88	88	87	85	85

### Weight

Extender Receptacle	Short Receptacle	Plug	Backshell
7 gr	6 gr	9 gr	4 - 7gr
0,015 lbs	0,013 lbs	0,020 lbs	0,009 - 0,015 lbs

### Recommended mounting for receptacle screw torque

$0,5 \pm 0,1 \text{ N.m}$  or  $4,4 \pm 0,9 \text{ In. LbF}$   
 When using DEUSCH integrated nut plate PN 787-0016-00 (see page 6)

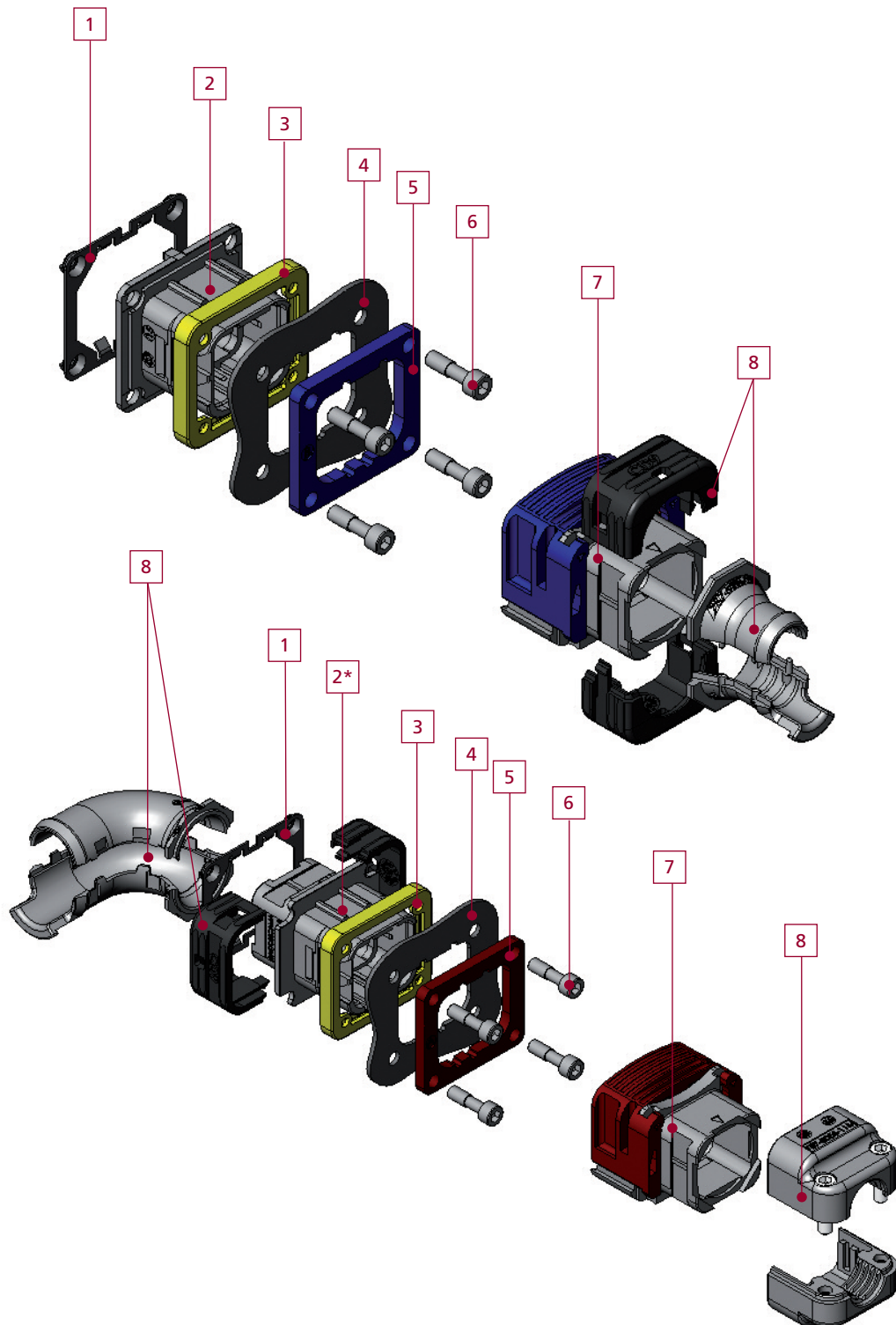

- |                               |                                  |
|-------------------------------|----------------------------------|
| 1 - Nut plate (option).       | 5 - Color coding plate (option). |
| 2 - Short receptacle.         | 6 - Screws (non delivered).      |
| 2* - Extender receptacle.     | 7 - Plug.                        |
| 3 - Sealing gasket (option).  | 8 - Backshell.                   |
| 4 - Panel (up to 2 mm thick). |                                  |

## DEUTSCH designation system for the shells

Example of order

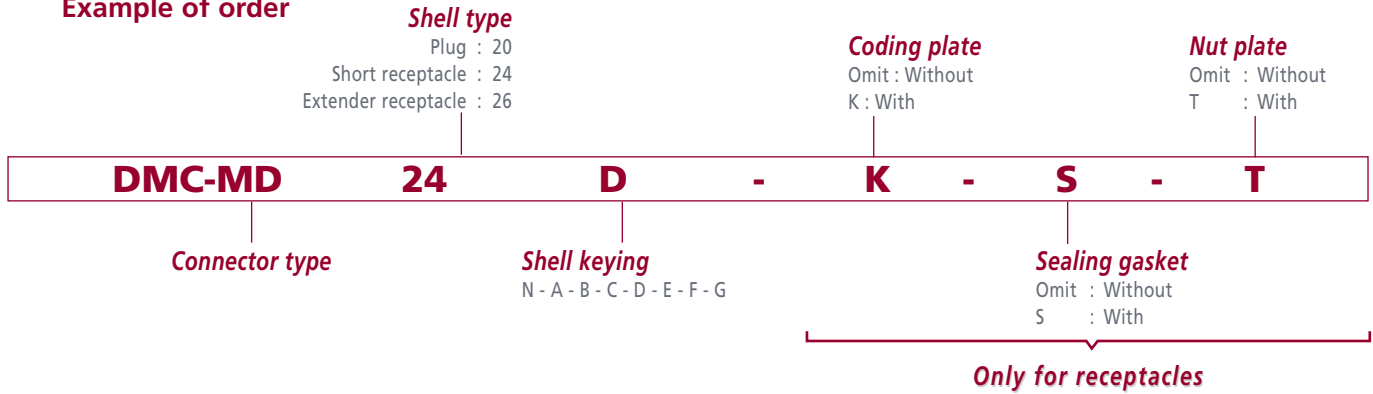

## DEUTSCH designation system for the accessories

Example of order

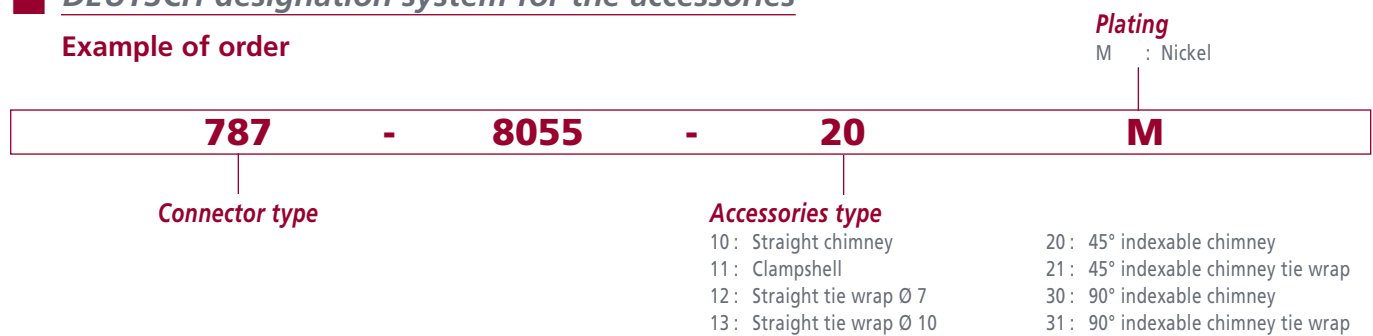

## Standard designation system for the shells

Example of order

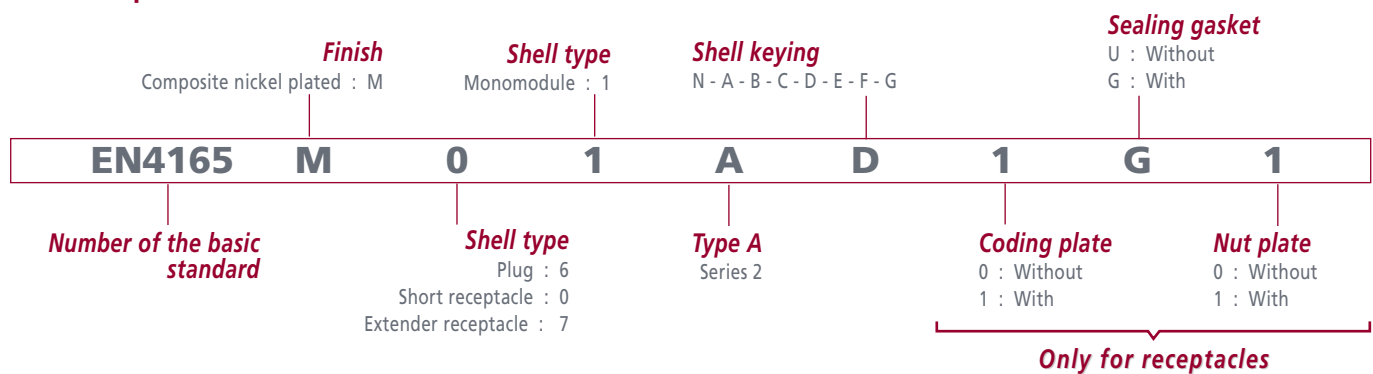

## Standard designation system for the accessories

Example of order

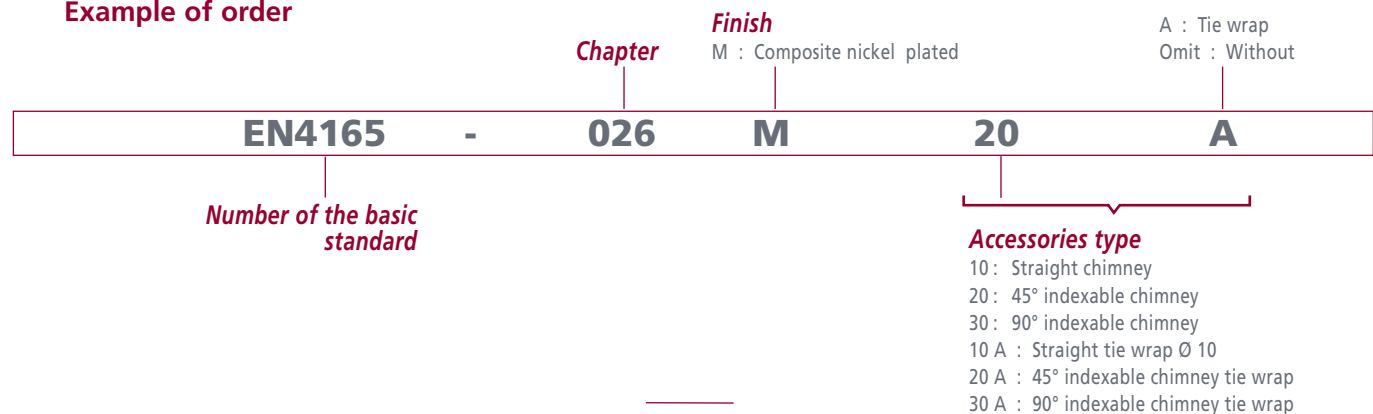

## Backshells

STRAIGHT CLAMPSHELL  
787-8055-11M  
Screws delivered



STRAIGHT CHIMNEY  
787-8055-10M  
EN4165-026M10



STRAIGHT CHIMNEY TIE WRAP Ø 7  
787-8055-12M



STRAIGHT CHIMNEY TIE WRAP Ø 10  
787-8055-13M  
EN4165-026M10A



45° INDEXABLE CHIMNEY  
787-8055-20M  
EN4165-026M20



45° INDEXABLE CHIMNEY TIE WRAP  
787-8055-21M  
EN4165-026M20A



90° INDEXABLE CHIMNEY  
787-8055-30M  
EN4165-026M30



90° INDEXABLE CHIMNEY TIE WRAP  
787-8055-31M  
EN4165-026M30A



## Plugs

DMC-MD 20 N  
BACC65BUMN  
EN4165M61AN

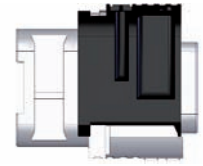

DMC-MD 20 A  
BACC65BUMA  
EN4165M61AA

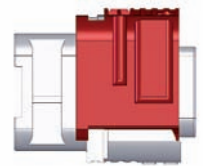

DMC-MD 20 B  
BACC65BUMB  
EN4165M61AB

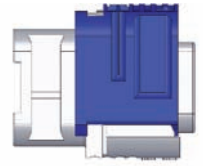

DMC-MD 20 C  
BACC65BUMC  
EN4165M61AC

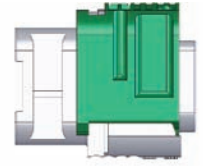

DMC-MD 20 D  
BACC65BUMD  
EN4165M61AD

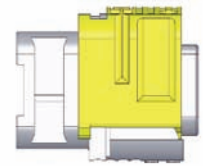

DMC-MD 20 E  
EN4165M61AE

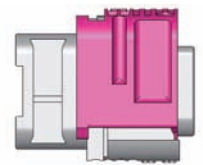

DMC-MD 20 F  
EN4165M61AF

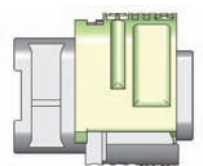

DMC-MD 20 G  
EN4165M61AG

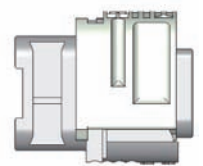

DEUTSCH Part numbers (DMC-M / 787)  
BOEING Part numbers (BACC)  
STANDARD Part numbers (EN4165)

## Receptacles

### EXTENDER RECEPTACLE

DMC-MD 26 \*X  
BACC65CAM \*X  
EN4165M71A \*X

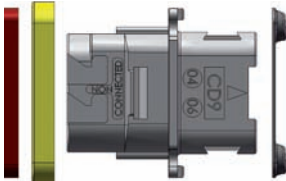

- : To be ordered separately (for BACC65 part numbers)

*X						
N	A	B	C	D	E	F

### SHORT RECEPTACLE

DMC-MD 24 \*X  
BACC65BVM \*X  
EN4165M01A \*X

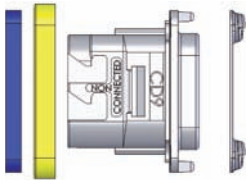

- : To be ordered separately (for BACC65 part numbers)

**NO ACCESSORY CAN BE FIXED ON THIS RECEPTACLE**

## Backshells



STRAIGHT CLAMPSHELL  
**787-8055-11M**  
Screws delivered



STRAIGHT CHIMNEY  
**787-8055-10M**  
EN4165-026M10



STRAIGHT CHIMNEY TIE WRAP Ø 7  
**787-8055-12M**



STRAIGHT CHIMNEY TIE WRAP Ø 10  
**787-8055-13M**  
EN4165-026M10A



45° INDEXABLE CHIMNEY  
**787-8055-20M**  
EN4165M20



45° INDEXABLE CHIMNEY TIE WRAP  
**787-8055-21M**  
EN4165-026M21A



90° INDEXABLE CHIMNEY  
**787-8055-30M**  
EN4165M30



90° INDEXABLE CHIMNEY TIE WRAP  
**787-8055-31M**  
EN4165-026M30A

## High speed chimney

(consult us)



Note : These backshells have been specially developed for high speed wire management. Backshells have to be ordered with the DMC-M 99-02-XX inserts.

## Optionnal parts for receptacle

### Colored keying plate

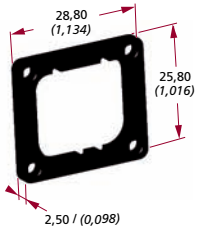

- N : 787-0015-00 EN4165-25CN
- A : 787-0015-01 EN4165-25CA
- B : 787-0015-02 EN4165-25CB
- C : 787-0015-03 EN4165-25CC
- D : 787-0015-04 EN4165-25CD
- E : 787-0015-05 EN4165-25CE
- F : 787-0015-06 EN4165-25CF
- G : 787-0015-07 EN4165-25CG

### Sealing gasket

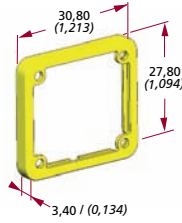

787-0011-00  
EN4165-25E

### Nut plate

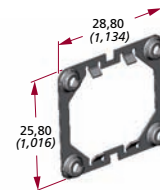

787-0016-00  
EN4165-25D

### Panel mounting bracket

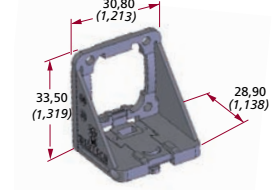

787-8014-00

## Protective caps



PROTECTION LEVEL	PLUG CAP 104-0236-00	RECEPTACLE CAP 104-0235-00	RECEPTACLE AND EXTENDER CAP WITH LANYARD 787-8011-00 WITHOUT LANYARD 787-8009-00	PLUG FLIGHT CAP 787-8010-00	RECEPTACLE AND EXTENDER FLIGHT CAP WITH LANYARD 787-8017-00 EN4165M3C WITHOUT LANYARD 787-8016-00
Shipping	X	X	-	-	-
Dust	X	X	X	X	X
EMI	-	-	X	X	X
Low pressure sealing	-	-	-	X	X

LANYARD  
787-8013-00

## Mounting bracket

### Locate mating parts

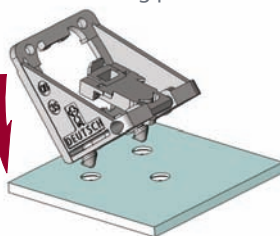

### Install rear dowels

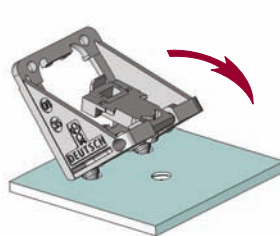

### Fix and snap in position

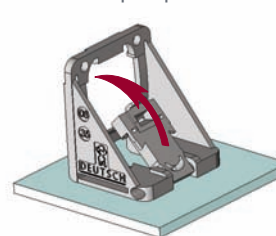

### Installed

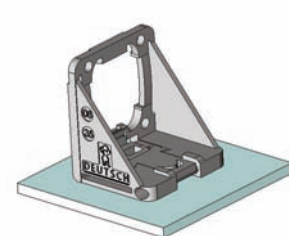

### Align receptacle with bracket

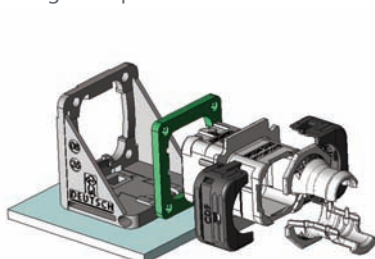

### Install and fix in position

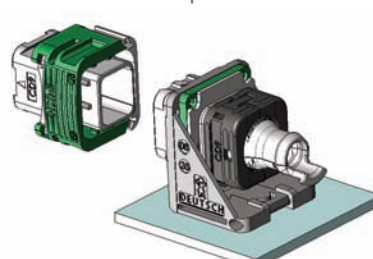



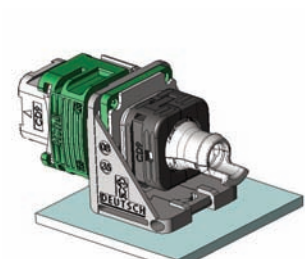







### Assembled





## Pin contacts as per MIL C 39029/58 and EN3155

Modules	Details	PART NUMBER CROSS
	20 contacts size 22	DMC-M 20-22 A* BAC110BC2022PNB EN4165A20-22 1*A
	12 contacts size 20	DMC-M 12-20 A* BAC110BC1220P*B EN4165A12-20 1*A
	8 contacts size 16	DMC-M 08-16 A* BAC110BC0816P*B EN4165A08-16 1*A
	4 contacts size 12	DMC-M 04-12 A* EN4165A04-12 1NA
	1 contact size 8	DMC-M 01-08 A* EN4165A01-08 1*A
	6 contacts size 16 + 5 contacts size 22	DMC-M 99-01 A* BAC110BC1622P*B EN4165A99-01 1*A
	20 contacts size 22	DMC-MA 20-22 A* EN4165A20A22 1*A
	6 contacts size 16 + 5 contacts size 22	DMC-MA 99-01 A* EN4165A99A01 1*A
	3 contacts size 20 + 8 contacts size 22	DMC-M 99-02 A* Gigabit insert (consult factory)
	8 contacts size 20 + 2 contacts size 16	DMC-M 99-10 A* EN4165A99-10 1*A
	Blanking module	DMC-M 00-00 AN EN4165A1*

Note : DMC-MA modules are Aluminium Cable contacts compliant and with EN3155-70 / 71 size 22.

Distribution modules use dedicated contacts based on standard EN3155-082.

DMC-M 99-02 are specific modules for Ethernet 1 Giga requirement.

## Socket contacts as per MIL C 39029/57 and EN3155

Modules	Details	PART NUMBER CROSS
	20 contacts size 22	DMC-M 20-22 B* BAC110BC2022SNB EN4165A20-22 1*B
	12 contacts size 20	DMC-M 12-20 B* BAC110BC1220S*B EN4165A12-20 1*B
	8 contacts size 16	DMC-M 08-16 B* BAC110BC0816S*B EN4165A08-16 1*B
	4 contacts size 12	DMC-M 04-12 B* EN4165A04-12 1*B
	1 contact size 8	DMC-M 01-08 B* EN4165A01-08 1*B
	6 contacts size 16 + 5 contacts size 22	DMC-M 99-01 B* BAC110BC1622S*B EN4165A99-01 1*B
	20 contacts size 22	DMC-MA 20-22 B* EN4165A20A221*B
	6 contacts size 16 + 5 contacts size 22	DMC-MA 99-01 B* EN4165A99A01 1*B
	3 contacts size 20 + 8 contacts size 22	DMC-M 99-02 B* Gigabit insert (consult factory)
	8 contacts size 20 + 2 contacts size 16	DMC-M 99-10 B* EN4165A99-10 1*B
	3 x 4 + 4 x 2 Contacts size 22	DMC-M 22-07 B* EN4165A2AY221*B
	5 x 4 Contacts size 22	DMC-M 22-05 B* EN4165A20Y221*B
	10 x 2 Contacts size 22	DMC-M 22-10 B* EN4165A2BY221*B

Aluminium cable technology compliant

Distribution modules

DEUTSCH Part numbers (DMC-M / 787)  
BOEING Part numbers (BACC)  
STANDARD Part numbers (EN4165)

## Receptacles & Plug

### Short receptacle

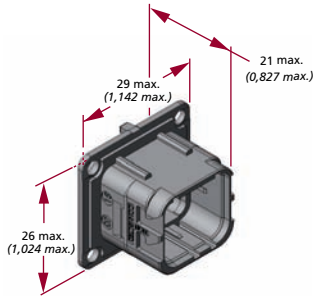

### Extender receptacle

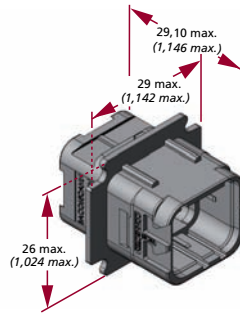

### Plug

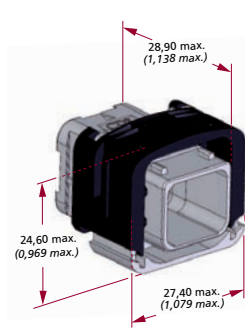

## Backshell / chimney indexation

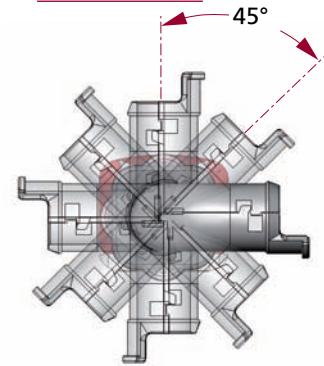

All backshells can be indexed in eight positions on the rear of plug and extender receptacle shell. This gives maximum flexibility during design and cable installation and reduces the number of variants and components.

## Mounting panel

### Short receptacle

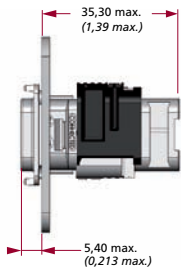

### Extender receptacle

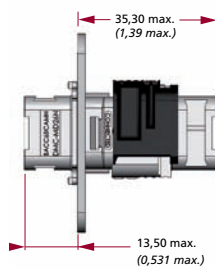

### Straight chimney

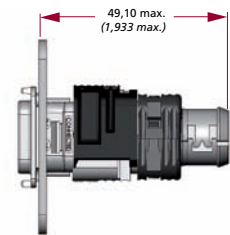

### Straight clampshell

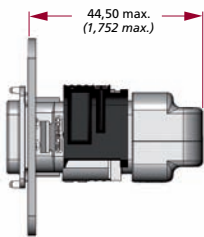

### Straight chimney tie wrap Ø 7

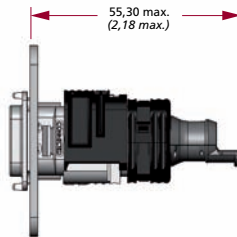

### Straight chimney tie wrap Ø 10

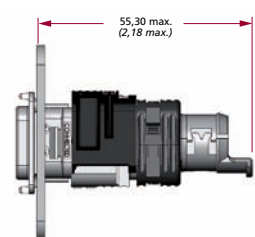

### 45° indexable chimney

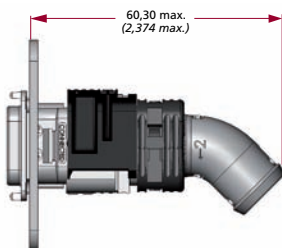

### 45° indexable chimney tie wrap

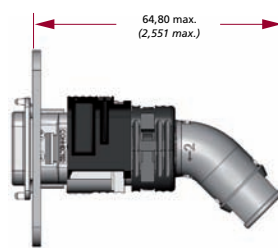

### 90° indexable chimney

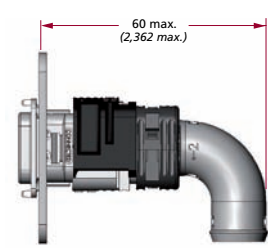

# Panel mounting cutout details Single Module EN4165

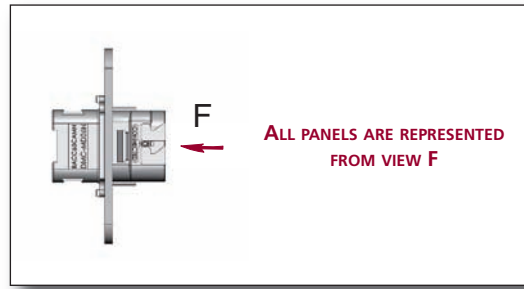

GENERIC DIMENSIONS

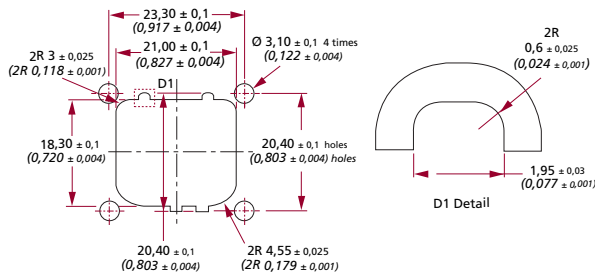

FREE

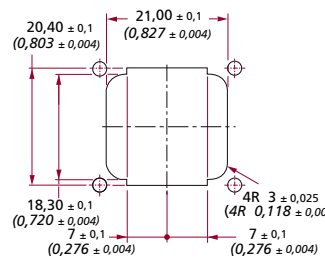

ORIENTATION

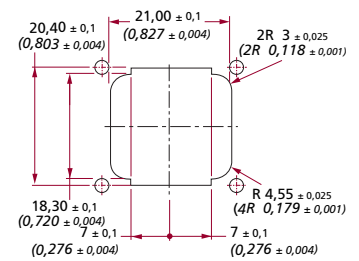

Note : Dimensions are in millimeters. Each hole  $\text{Ø } 3,1$  mm ( $\text{Ø } 0,122$  inch) must receive a screw (screw type 4-40)  
 Recommended thickness panel :  $0,8$  mm mini ( $0,031$  inch) -  $2$  mm maxi ( $0,079$  inch).

## Panel coding keying

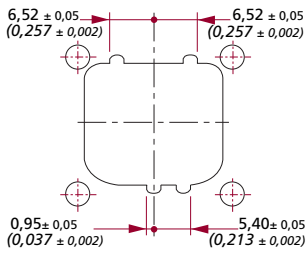

Coding N

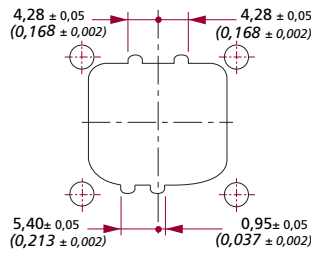

Coding A

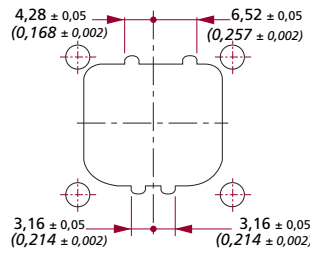

Coding B

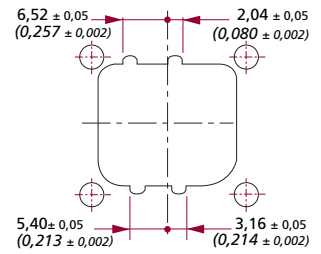

Coding C

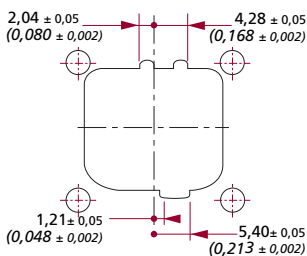

Coding D

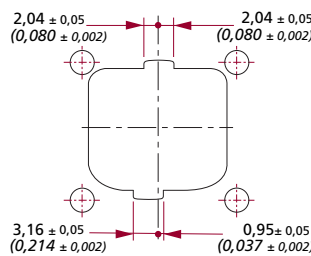

Coding E

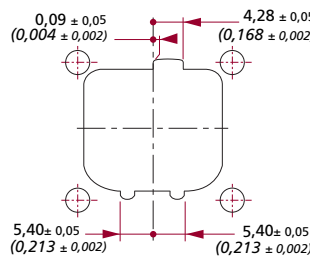

Coding F

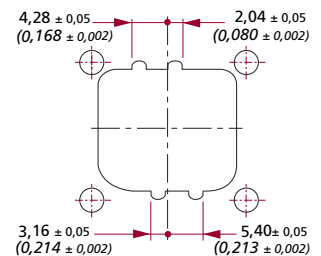

Coding G

## Panel mounting bracket cutout details

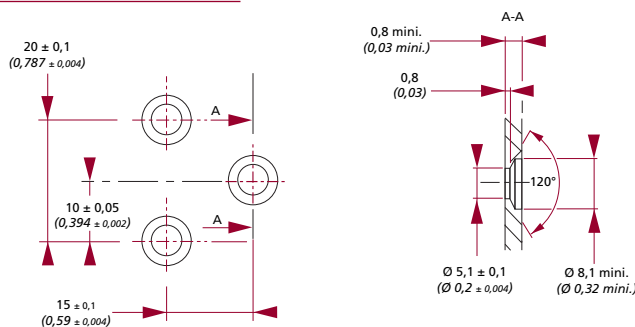

Overall dimensions and characteristics are given for indication guidance only. DEUTSCH reserves the right to modify them for production improvement reasons



[www.deutsch.net](http://www.deutsch.net)

## DEUTSCH GLOBAL SALES NETWORK

Contact your local sales office for further information:

### FRANCE

Connecteurs Electriques  
Deutsch  
17, rue Lavoisier BP 117  
27091 Evreux Cedex 09  
FRANCE  
Tel: +33 2 32 23 57 00

### GERMANY

Compagnie Deutsch GMBH  
Fraunhoferstrabe.11b  
82152 Martinsried  
GERMANY  
Tel: +49 89 89 91 570

### INDIA

DIPC  
104, Prestige Omega, EPIP Zone  
1st Phase, White Field Road  
BANGALORE 560066  
INDIA  
Tel: +91 80 404 66 501

### ISRAEL

Deutsch ECM  
P.O. Box 5082  
Ashkelon 78150  
Southern Industrial Zone  
ISRAEL  
Tel: +972 8 671 9020

### ITALY

Deutsch Italia S.R.L.  
Viale Jenner 51  
20159 Milano  
ITALY  
Tel: +39 02 37 617 44

### JAPAN

Deutsch Japan Ltd.  
4-3-28 Nishidai  
Itabashi-ku  
Tokyo 175-0045  
JAPAN  
Tel: +81 3 5922 1345

### UNITED KINGDOM

Deutsch UK  
Stanier Road  
St Leonards on Sea  
East Sussex TN38 9RF  
UK  
Tel: +44 (0) 1424 852721

### USA

Deutsch DAO  
250 Eddie Jones Way  
Oceanside, CA 92054  
USA  
Tel: +1 (760) 757-7500



DEUTSCH

For more information, technical  
assistance or custom solutions:  
email [ced@deutsch.net](mailto:ced@deutsch.net)